

# BLOCK SIDING INSTALLATION

**SIGNATURE & SUMMIT SERIES SHEDS**

v2 - MAY 2024

**PLEASE**



**READ THIS ENTIRE GUIDE  
CAREFULLY PRIOR TO  
STARTING INSTALLATION**

**BEFORE PROCEEDING ENSURE:**

**ALL WALLS ARE LEVEL, PLUMB, AND SQUARE.  
ALL DOORS ARE INSTALLED PROPERLY.**

**CALL US WITH QUESTIONS!**

**1-888-900-3933**

**TABLE OF CONTENTS:**

---

|   |              |
|---|--------------|
| METAL TRIM AND FLASHING OVERVIEW .....                | <b>0.2</b>   |
| DRIP EDGE INSTALLATION .....                          | <b>1-2</b>   |
| DOOR CASING INSTALLATION .....                        | <b>3-4</b>   |
| CORNER CAP INSTALLATION .....                         | <b>4</b>     |
| <br>  |              |
| BLOCK SIDING REVEAL INSTALLATION                      |              |
| - REFERENCE LINES .....                               | <b>5</b>     |
| - INSTALLING HORIZONTAL REVEAL .....                  | <b>6-7</b>   |
| - INSTALLING VERTICAL REVEAL .....                    | <b>7</b>     |
| <br>  |              |
| BLOCK SIDING INSTALLATION                             |              |
| - INSTALLING BOTTOM ROW .....                         | <b>8-10</b>  |
| - INSTALLING ADDITIONAL ROWS .....                    | <b>11</b>    |
| - INSTALLING AROUND WINDOWS .....                     | <b>12</b>    |
| <br>  |              |
| JAMES HARDIE <sup>®</sup> SIDING BEST PRACTICES ..... | <b>13-20</b> |

## METAL TRIM AND FLASHING OVERVIEW:

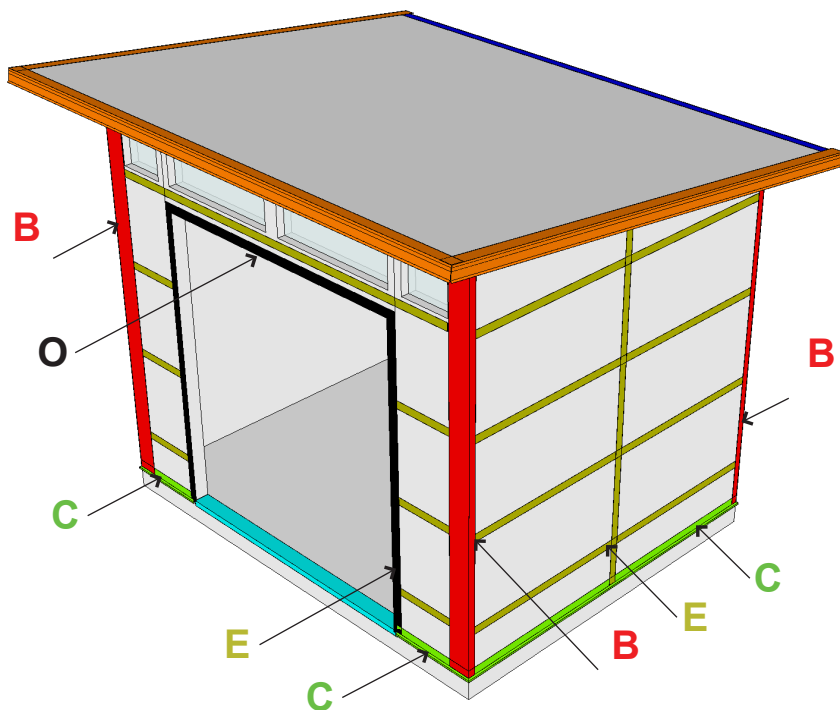
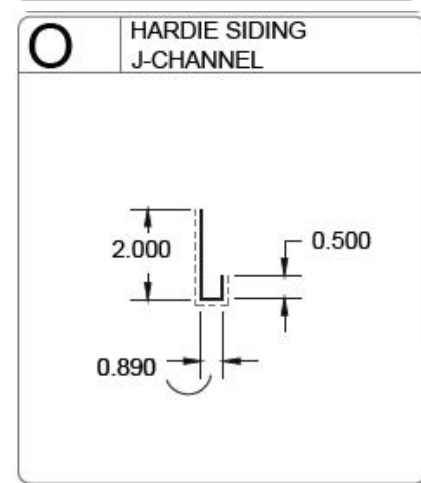
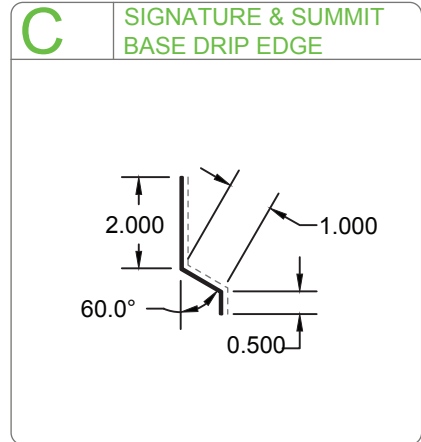
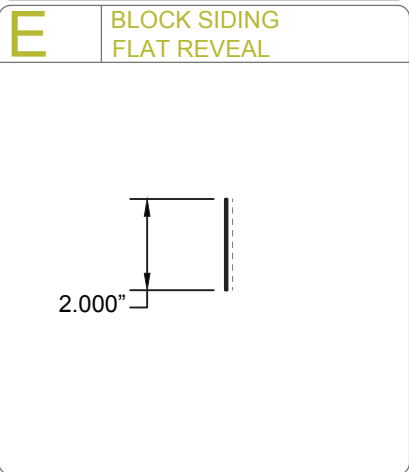
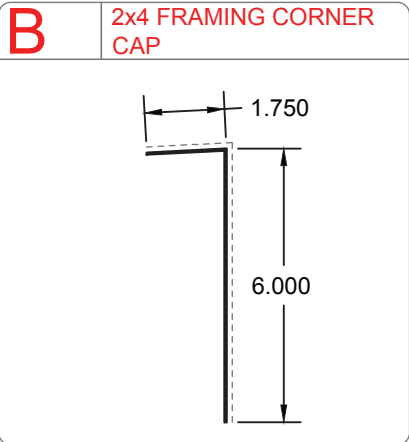
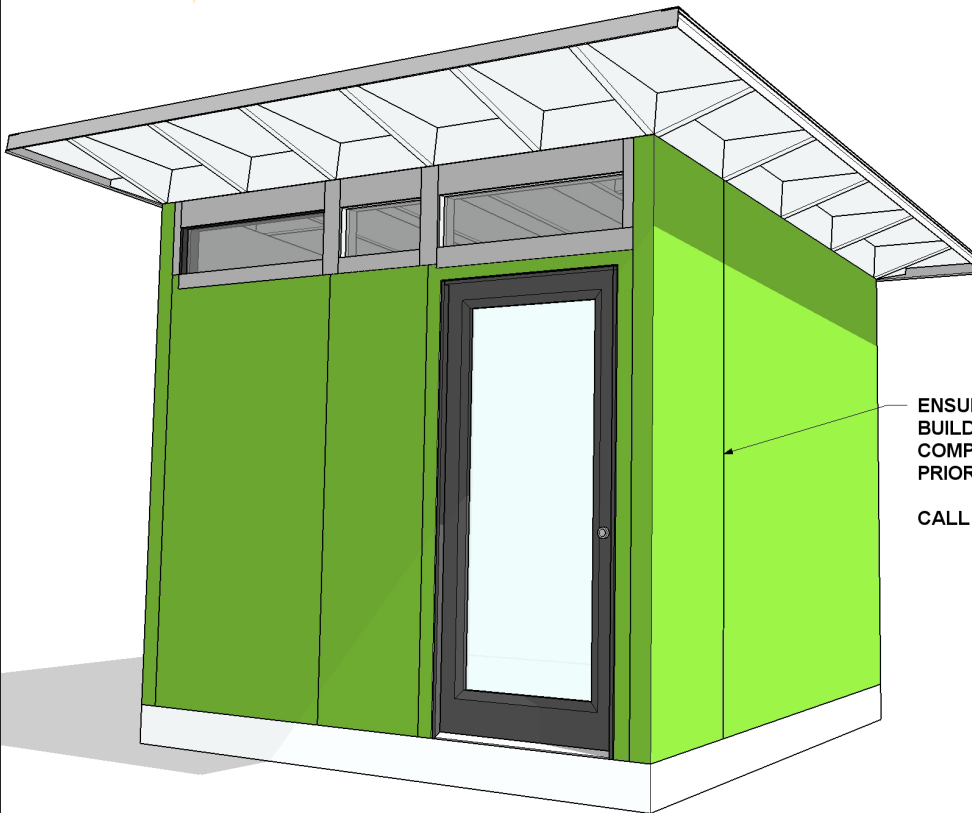

Fig 1a:



ENSURE THAT ALL OF THE STEPS IN THE BUILDING SHELL INSTALLATION GUIDE ARE COMPLETE AND THE DOOR(S) ARE INSTALLED PRIOR TO STARTING THE SIDING INSTALLATION.

CALL US WITH ANY QUESTIONS: 1-888-900-3933

Fig 1b:

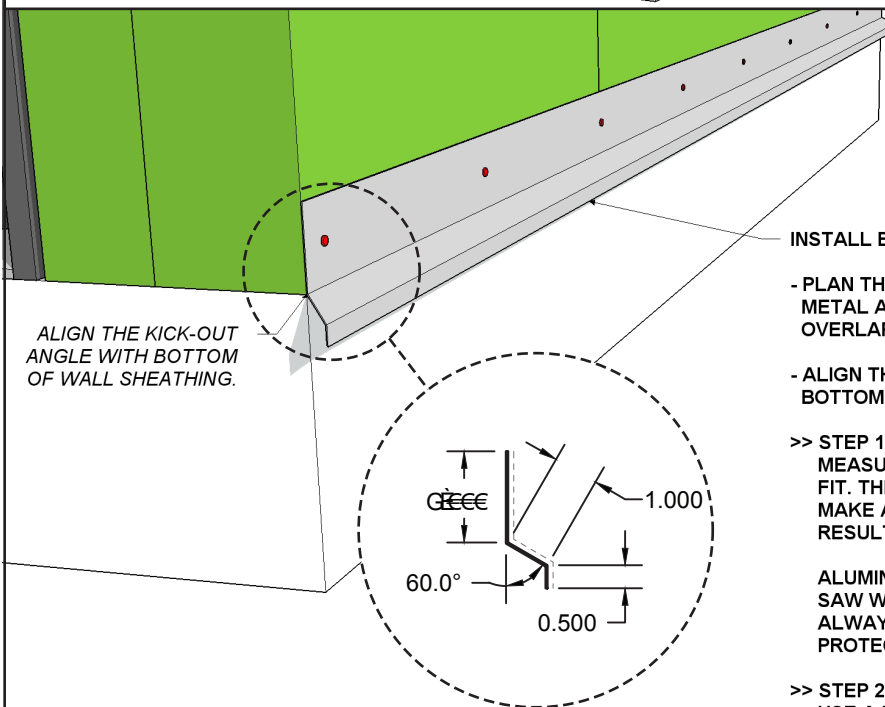

INSTALL BASE DRIP EDGE (TRIM PROFILE 'C'):

- PLAN THE SPLICE LOCATIONS, IF MULTIPLE PIECES OF METAL ARE USED, IN THE LEAST VISIBLE LOCATIONS. OVERLAP THE METAL 2-3".

- ALIGN THE KICK-OUT ANGLE OF THE FLASHING WITH THE BOTTOM OF THE WALL SHEATHING.

>> STEP 1:  
MEASURE THE BUILDING WALL AND CUT THE TRIM TO FIT. THE DRIP EDGE MEETS UP AT BUILDING CORNERS. MAKE ALL CORNER CUTS 45° MITER CUTS FOR BEST RESULTS.

ALUMINUM CAN BE CUT USING A HACKSAW OR CHOP SAW WITH A HIGH TOOTH COUNT CARBIDE BLADE. ALWAYS WEAR THE APPROPRIATE EYE AND EAR PROTECTION!

>> STEP 2:  
USE A PNEUMATIC BRAD NAILER, WITH 3/4" GALVANIZED BRAD NAILS, TO SECURE THE DRIP EDGE TO THE SHED. NAIL ~12" ON CENTER ALONG VERTICAL LEG OF DRIP EDGE. USE A CARPENTER'S LEVEL TO ENSURE DRIP EDGE REMAINS LEVEL DURING INSTALLATION.

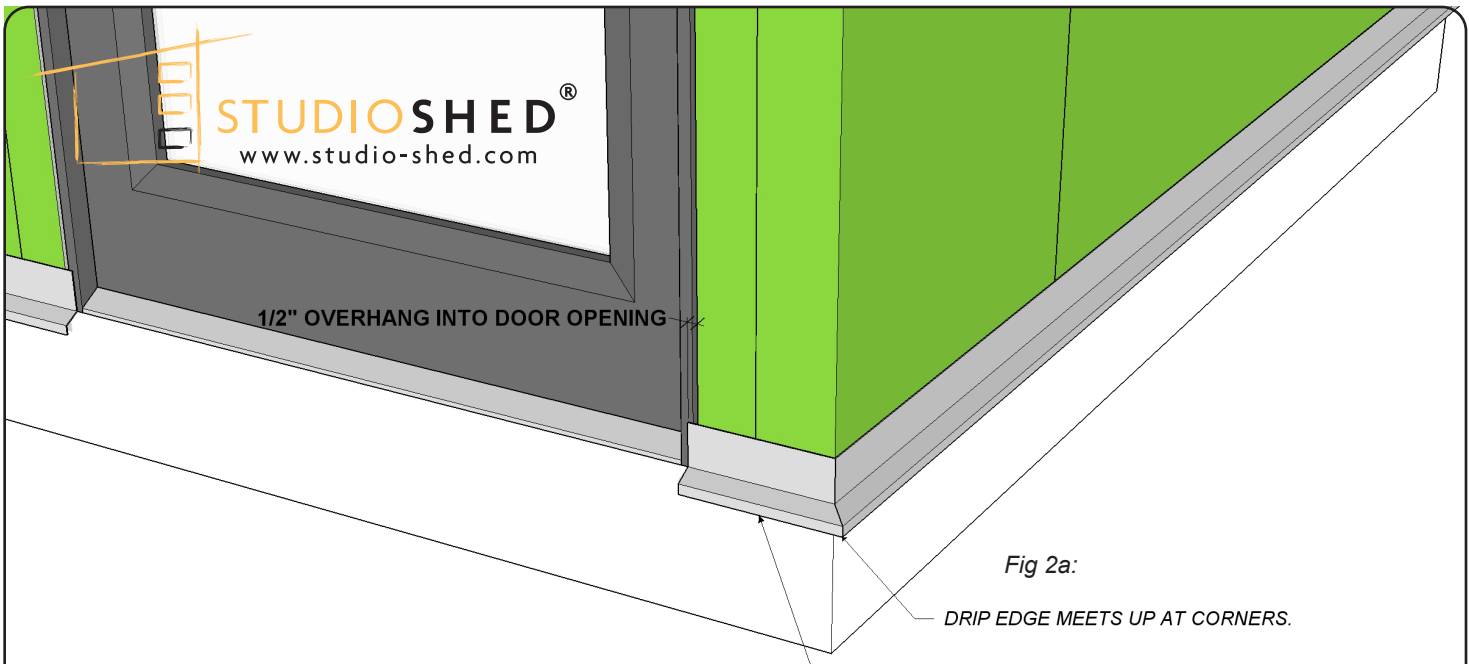

Fig 2a:

DRIP EDGE MEETS UP AT CORNERS.

INSTALL BASE DRIP EDGE (TRIM PROFILE 'C'):

>> STEP 3:  
 SQUARE CUT DRIP EDGE AT EACH SIDE OF DOOR  
 OPENING(S). OVERHANG DRIP EDGE 1/2" INTO DOOR  
 OPENING(S) TO COVER THE GAP BETWEEN THE  
 ROUGH OPENING AND DOOR JAMB.

NAIL TO THE SHED USING METHOD DESCRIBED IN  
 FIG 1a STEP #2.

Fig 2b:



INSTALL BASE DRIP EDGE (TRIM PROFILE 'C'):

>> STEP 4:  
 APPLY ZIP SYSTEM™ TAPE ALONG THE TOP  
 SEAM OF THE DRIP EDGE ON ALL SIDES. THE  
 TAPE SHOULD BE HALF ON THE WALL AND  
 HALF ON THE VERTICAL LEG OF THE DRIP EDGE.

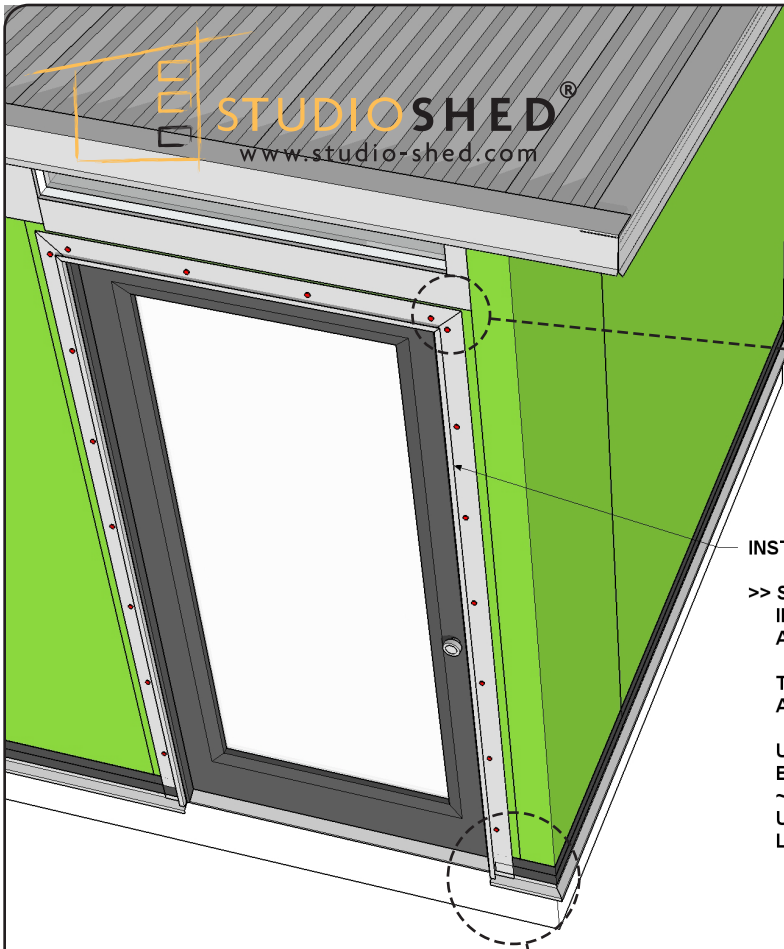
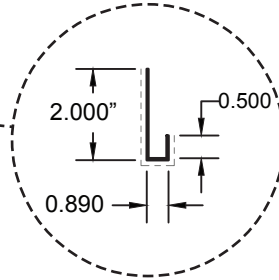

Fig 3a:



INSTALL DOOR CASING (TRIM PROFILE O).

>> STEP 1:  
INSTALL PRE-CUT DOOR CASING J-CHANNEL (PROFILE O),  
AROUND DOOR OPENING.

TRIM WILL EXTEND 1/2" INTO ROUGH DOOR OPENING  
AND WILL OVERLAP DOOR JAMB ~1/4" ALL AROUND.

USE A PNEUMATIC BRAD NAILER, WITH 3/4" GALVANIZED  
BRAD NAILS, TO SECURE THE TRIM TO THE SHED. NAIL  
~12" ON CENTER ALONG THE LONG LEG OF THE CASING.  
USE A CARPENTER'S LEVEL TO ENSURE TRIM REMAINS  
LEVEL DURING INSTALLATION.

Fig 3b:

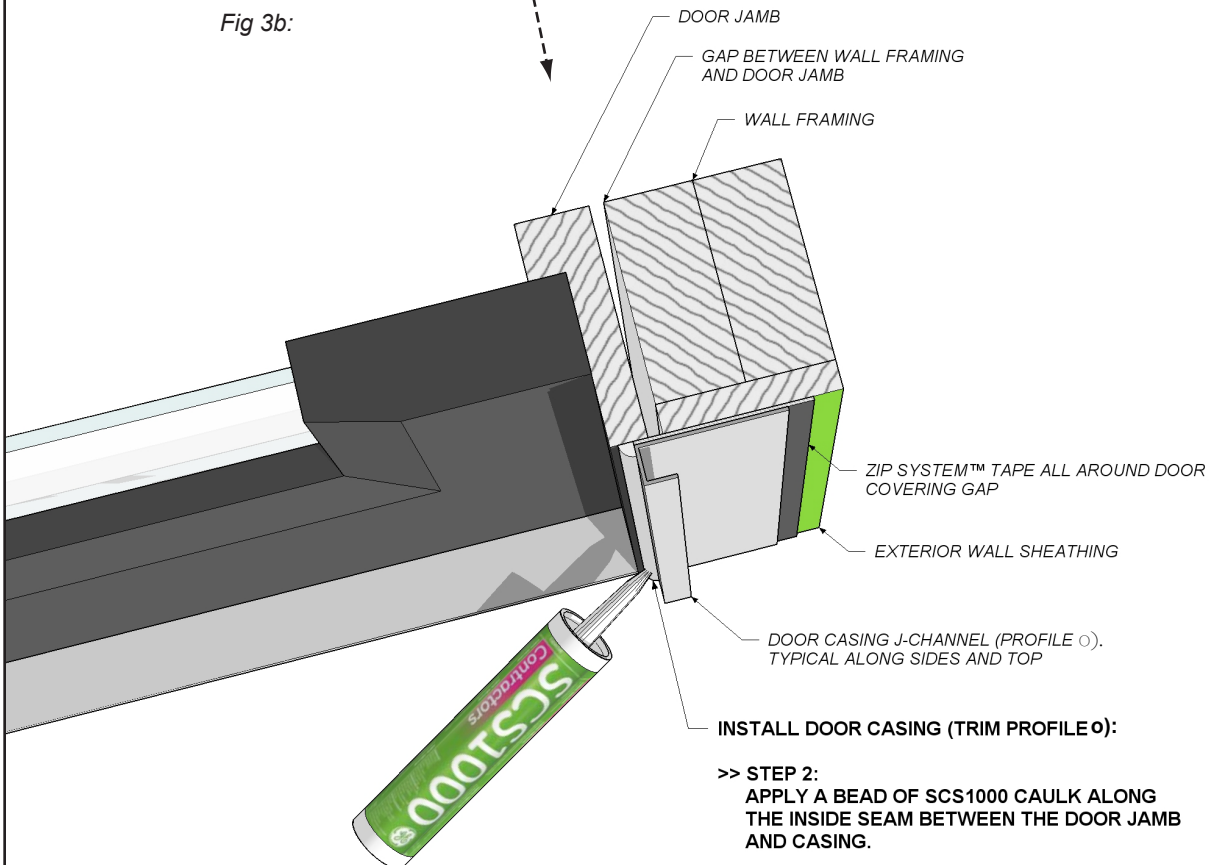

INSTALL DOOR CASING (TRIM PROFILE O):

>> STEP 2:  
APPLY A BEAD OF SCS1000 CAULK ALONG  
THE INSIDE SEAM BETWEEN THE DOOR JAMB  
AND CASING.

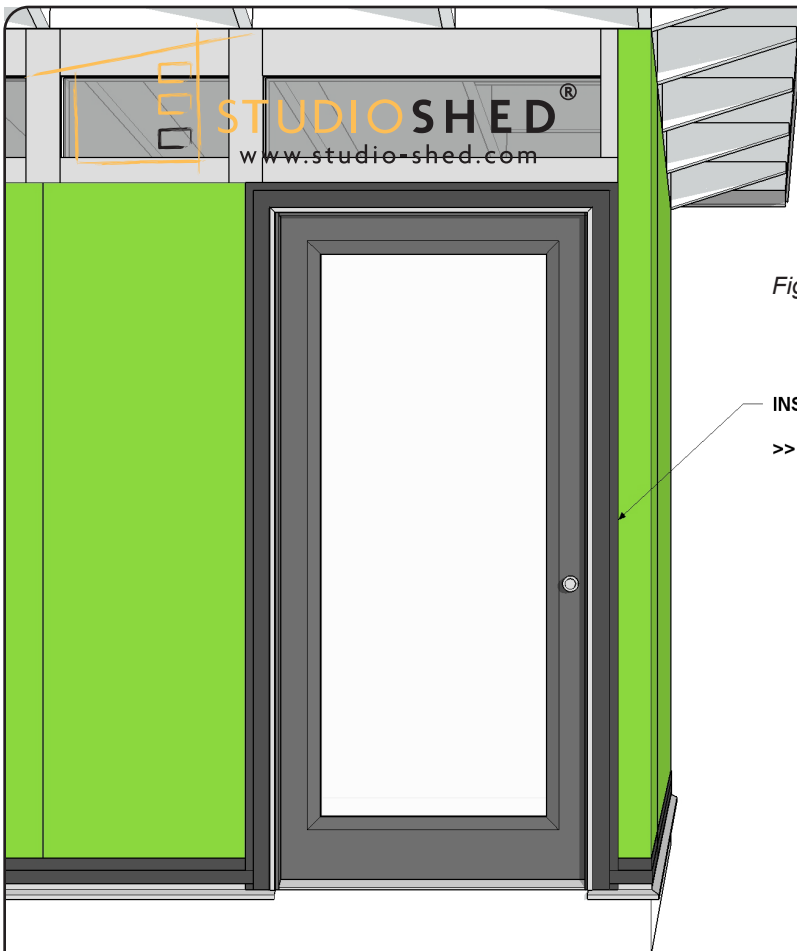

Fig 4a:

INSTALL DOOR CASING (TRIM PROFILE **O**).

>> STEP 3:  
FOR ADDITIONAL WEATHER PROTECTION, APPLY ZIP SYSTEM TAPE AROUND THE ENTIRE PERIMETER OF THE DOOR CASING. COVER THE ENTIRE LONG LEG OF THE METAL CASING. THIS WILL LEAVE ~1 3/4" OF TAPE THAT WILL BE APPLIED TO THE SHED.

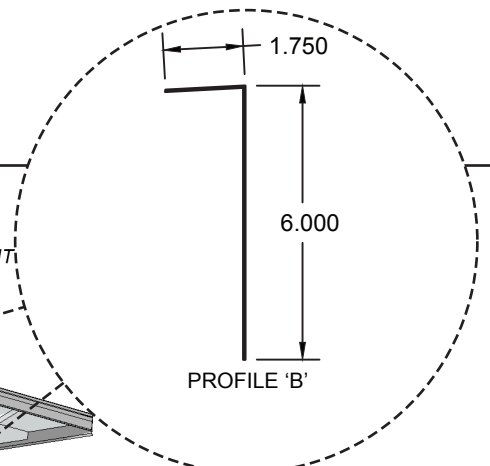
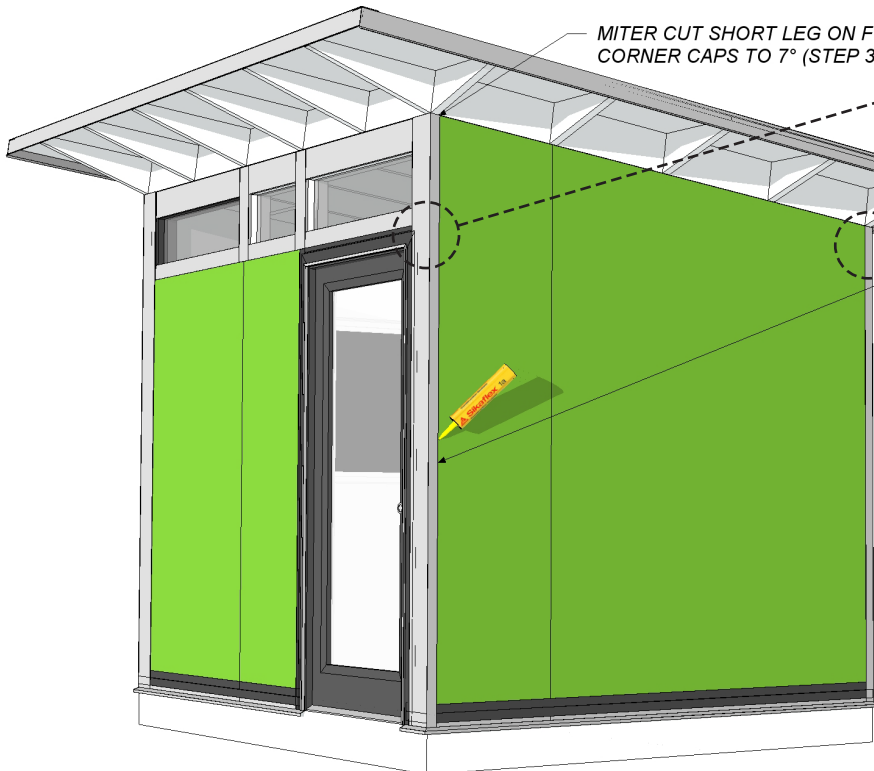

Fig 4b:

MITER CUT SHORT LEG ON FRONT CORNER CAPS TO 7° (STEP 3).

INSTALL CORNER CAPS (TRIM PROFILE 'B').

- DO NOT USE NAILS TO SECURE!
- BLUE PAINTERS TAPE MAY BE USED TO HOLD THE TRIM IN PLACE WHILE THE ADHESIVE DRIES.
- >> STEP 1:  
MEASURE EACH CORNER FROM THE TOP OF THE KICK-OUT ON THE DRIP EDGE TO THE TOP OF THE WALL SHEATHING.
- >> STEP 2:  
CUT THE FOUR CORNER CAPS TO THE LENGTHS MEASURED DURING STEP 1.
- >> STEP 3:  
MITER CUT SHORT LEG, ON FRONT CORNER CAPS, TO A 7° ANGLE TO MATCH THE ROOF SLOPE.
- >> STEP 4:  
ADHERE THE CORNER CAP TO THE SHED BY APPLYING SIKAFLEX ADHESIVE TO THE BACKSIDE OF THE METAL. THE SHORT LEG OF THE TRIM WILL BE ON THE SIDE WALLS.





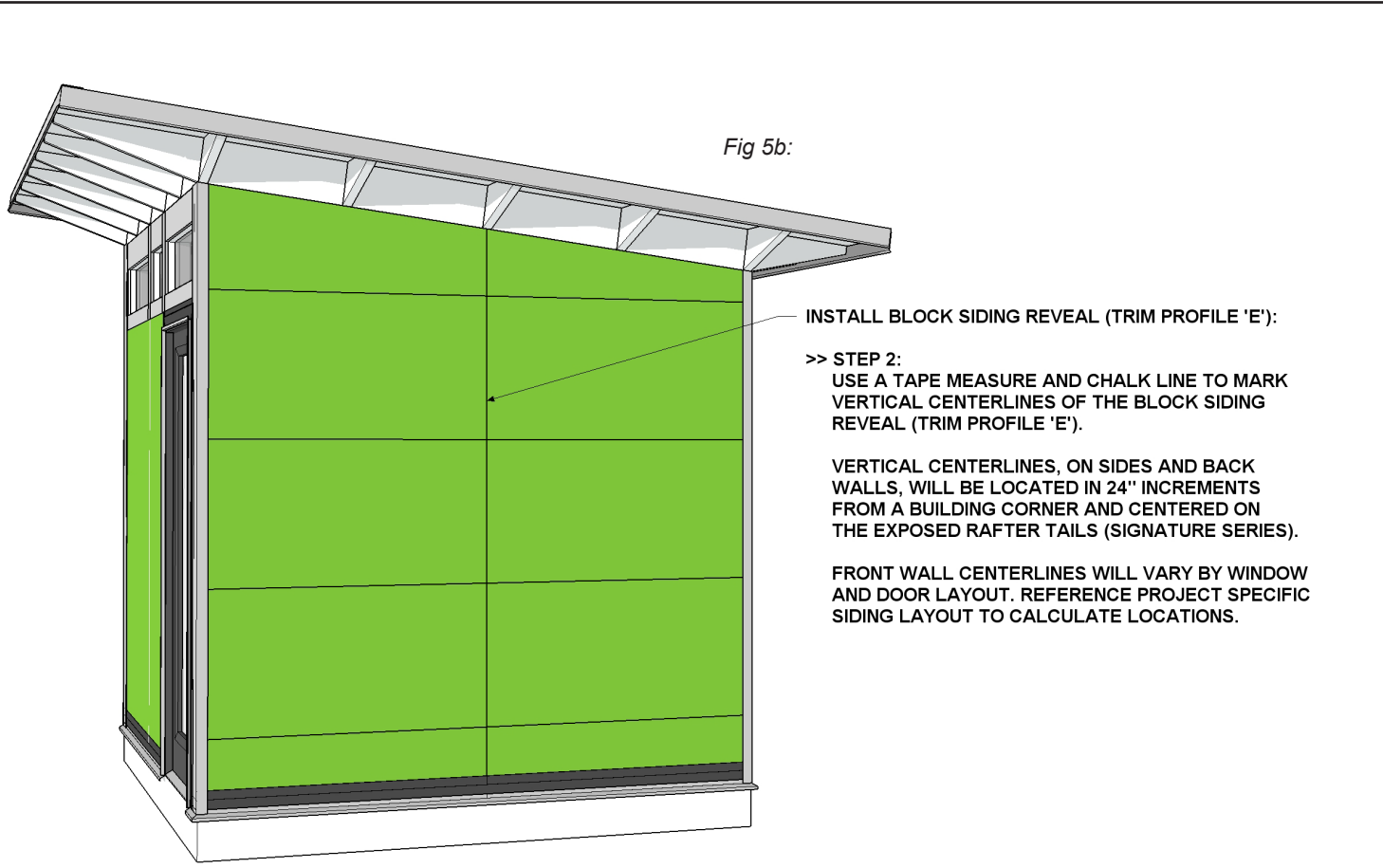
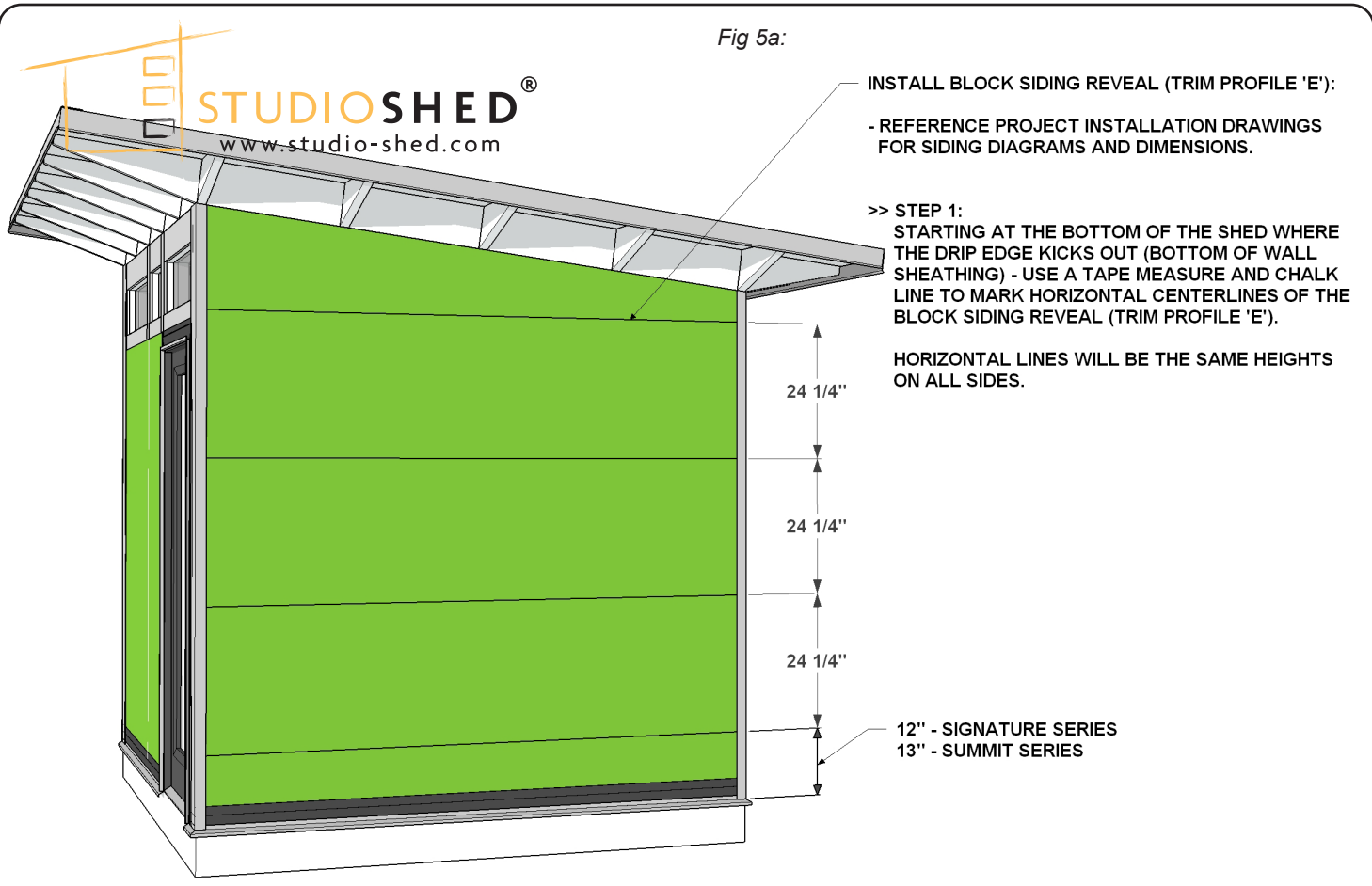
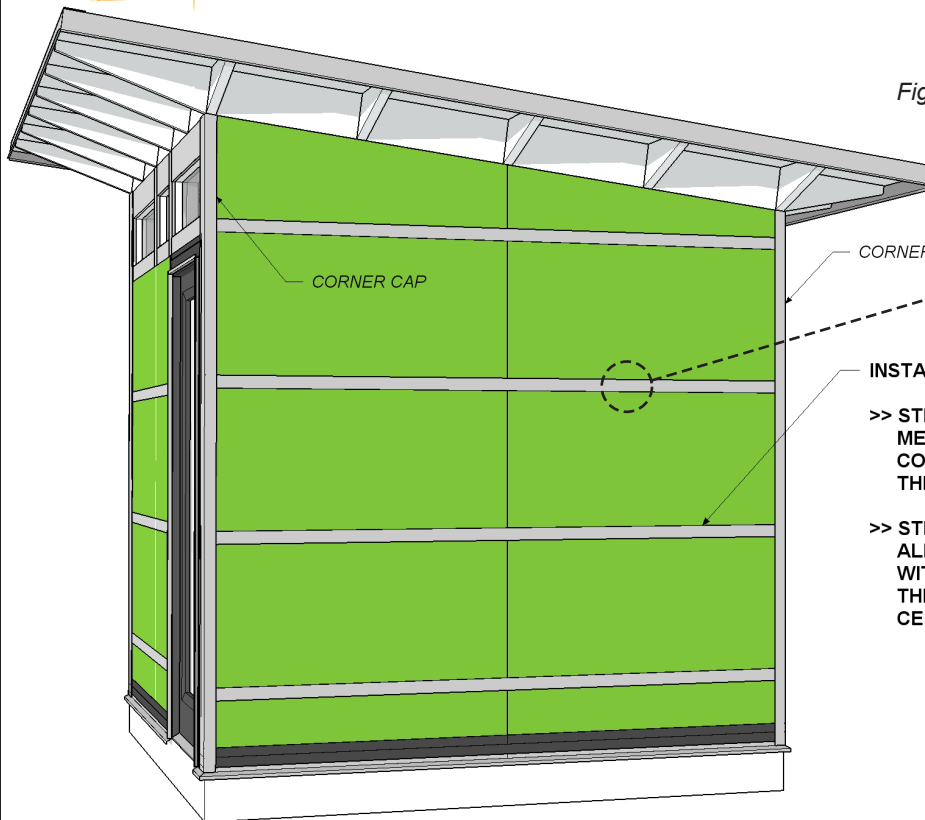
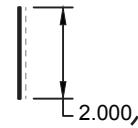

Fig 6a:



CORNER CAP

CORNER CAP



INSTALL BLOCK SIDING REVEAL (TRIM PROFILE 'E'):

>> STEP 3:  
MEASURE THE HORIZONTAL DISTANCE BETWEEN THE CORNER CAPS, INSTALLED DURING FIG 2b, AND CUT THE BLOCK SIDING REVEAL (TRIM PROFILE 'E') TO FIT.

>> STEP 4:  
ALIGN THE MIDDLE OF THE BLOCK SIDING REVEAL WITH THE CENTERLINES CREATED DURING STEP 1. THE EDGE OF THE TRIM WILL BE 1" ABOVE THE CENTERLINES.

Fig 6b:

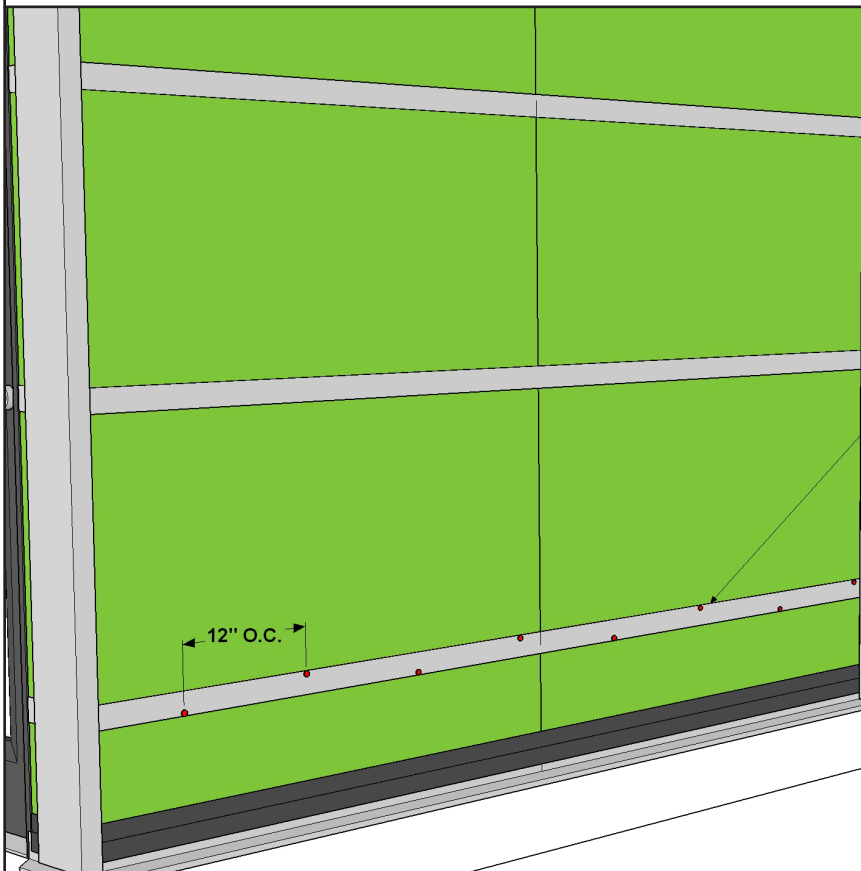

INSTALL BLOCK SIDING REVEAL (TRIM PROFILE 'E'):

>> STEP 5:  
USE A PNEUMATIC BRAD NAILER, WITH 3/4" LONG GALVANIZED BRAD NAILS, TO SECURE THE TRIM TO THE SHED WALL.

ENSURE THE METAL IS TIGHT AND FREE OF WRINKLES BY WORKING FROM ONE END TO THE OTHER.

SPACE NAILS ~12" ON CENTER, STAGGERED FROM TOP TO BOTTOM AND A MAXIMUM OF 1/4" IN FROM THE EDGES.

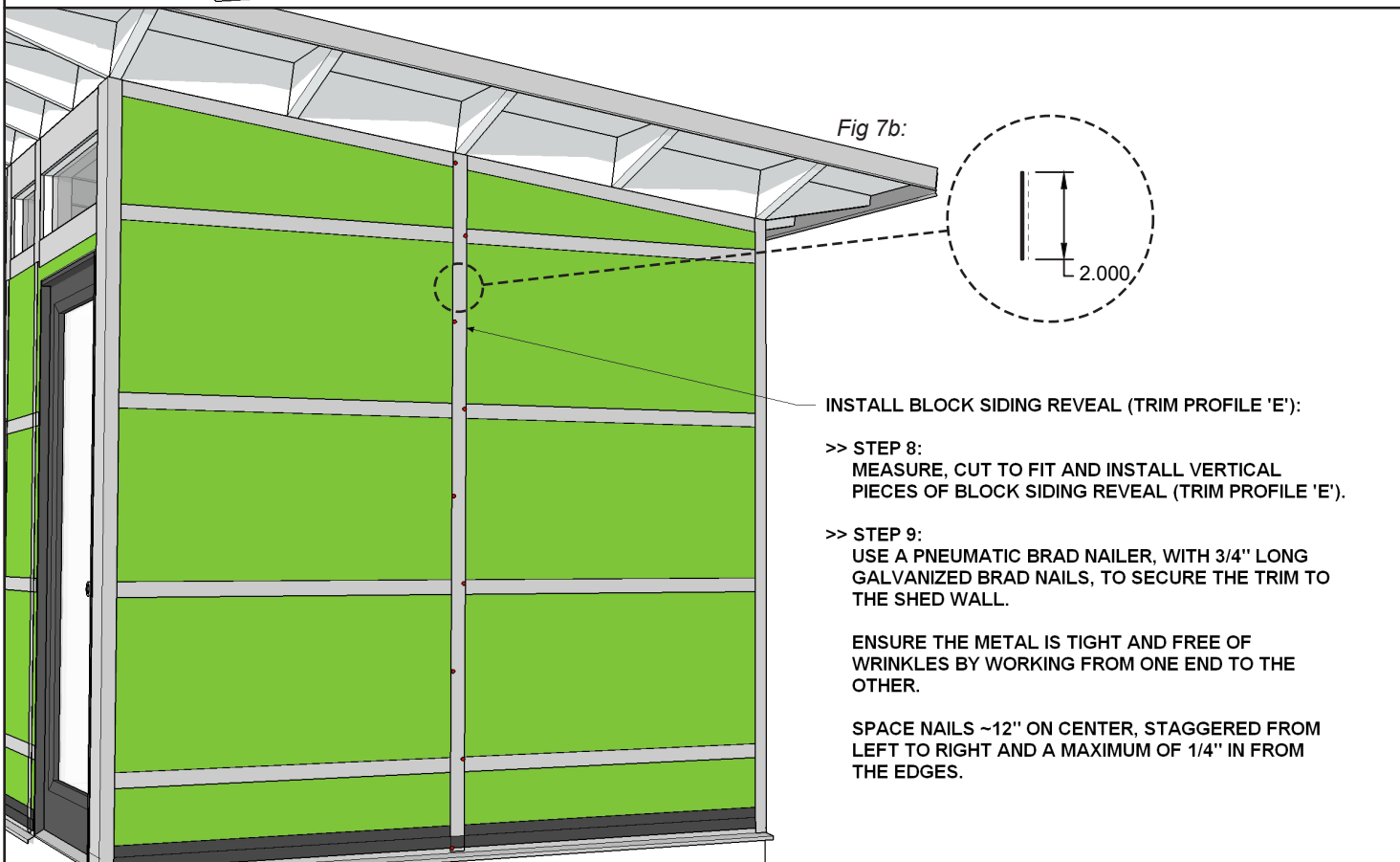
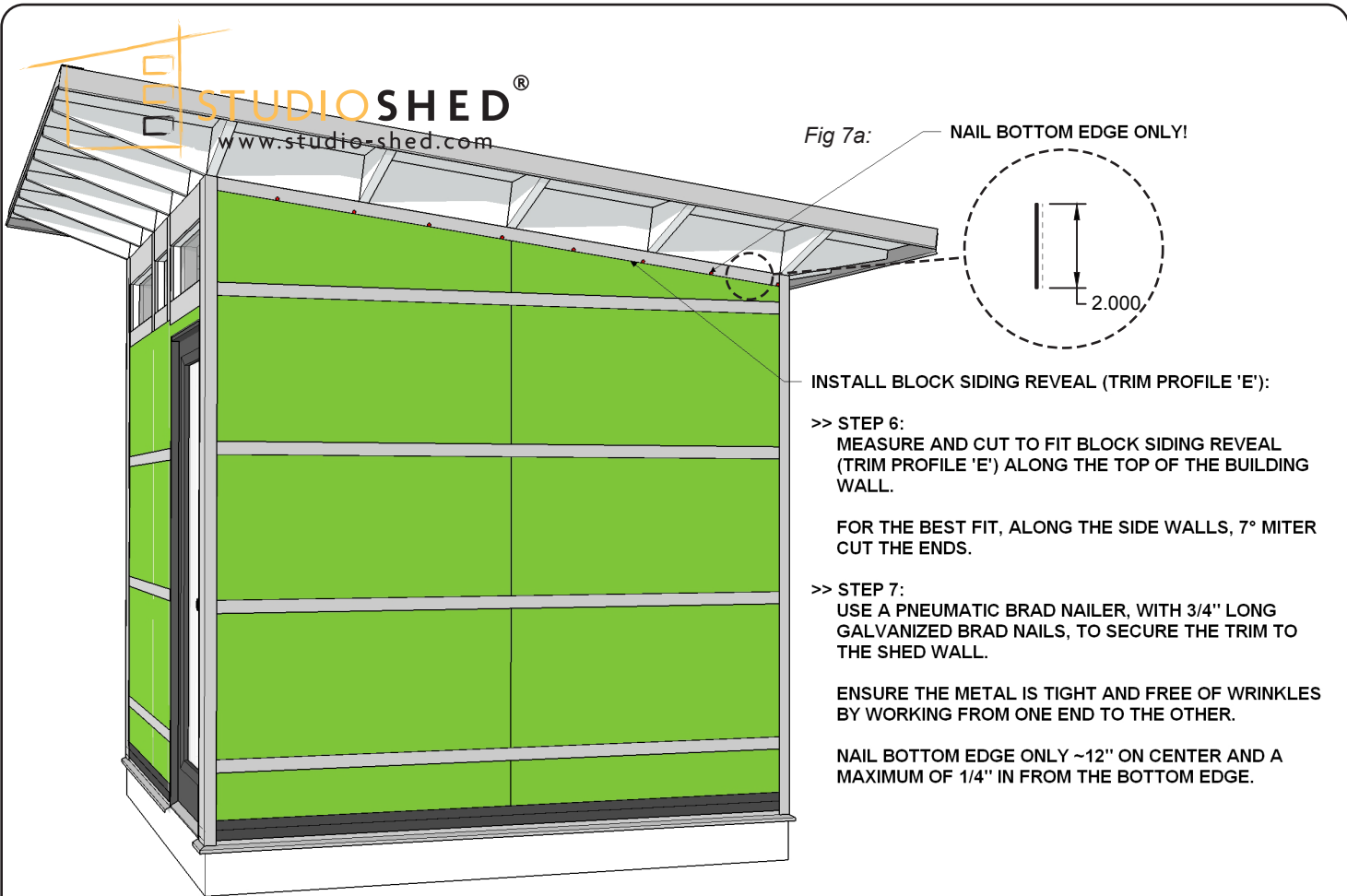

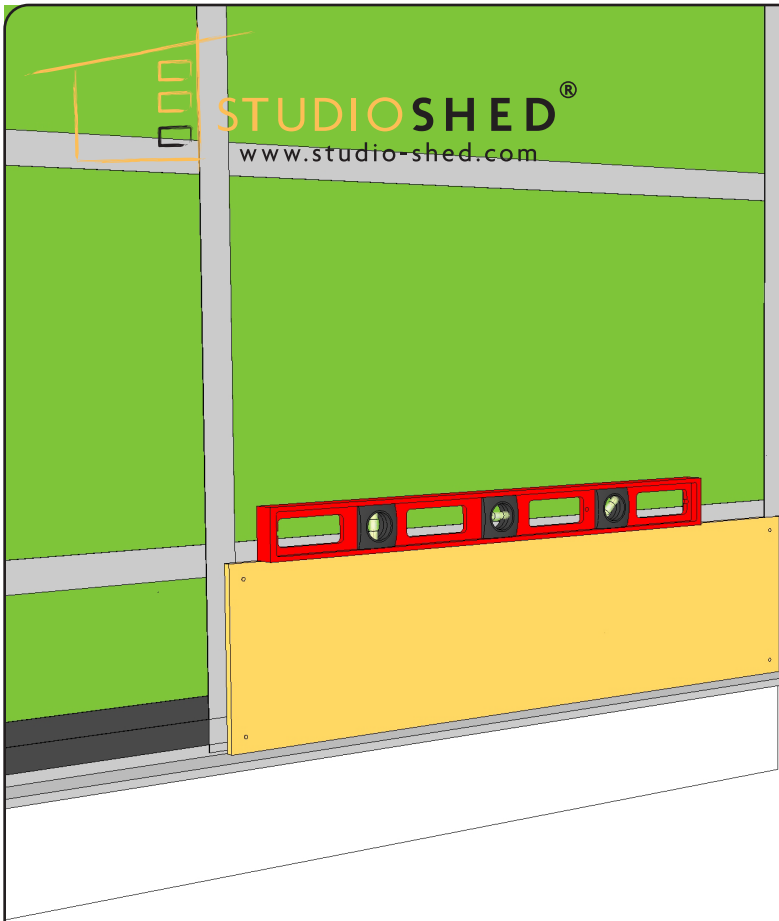

Fig 8a:

**INSTALL BLOCK SIDING PANELS:**

- REFERENCE PROJECT INSTALLATION DRAWINGS FOR SIDING DIAGRAMS AND DIMENSIONS.

- SIDING PANELS WILL BE LABELED (ON BACK) BY LOCATION.

>> **STEP 1:**  
START AT A BOTTOM CORNER. PLACE THE BLOCK SIDING PANEL AGAINST THE SHED WALL. THE BOTTOM OF THE SIDING WILL SIT ON TOP OF THE KICK-OUT ON THE BASE DRIP EDGE/ BOTTOM OF WALL SHEATHING.

>> **STEP 2:**  
USE A CARPENTER'S LEVEL TO ENSURE PANEL IS LEVEL PRIOR TO FASTENING IT TO THE WALL.

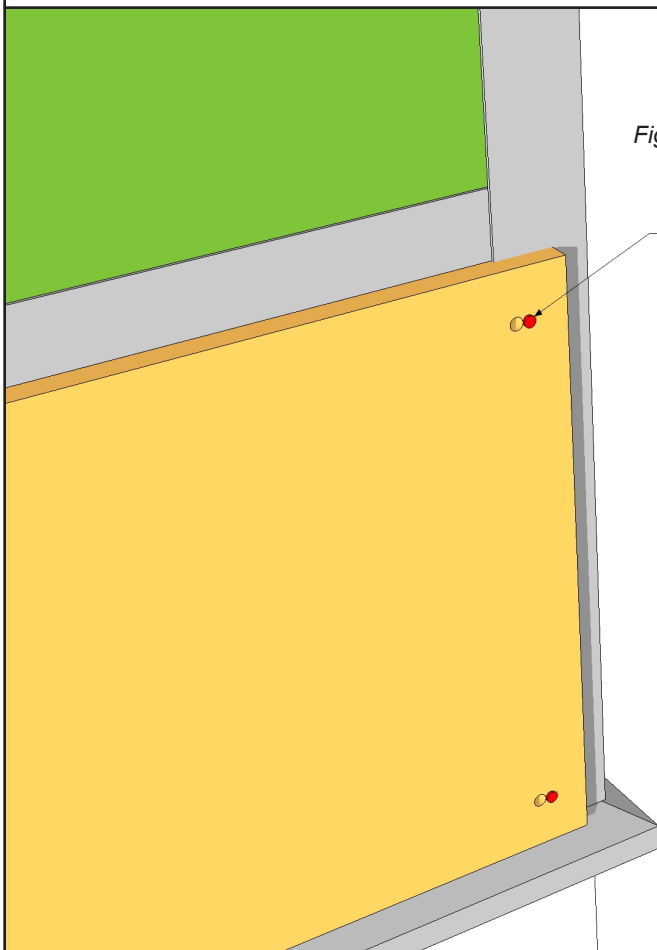

Fig 8b:

**INSTALL BLOCK SIDING PANELS:**

>> **STEP 3:**  
USE A PNEUMATIC BRAD NAILER, WITH 1 1/2" GALVANIZED BRAD NAILS, TO SECURE THE SIDING PANEL TO THE SHED.

PLACE NAILS ~3/16" FROM THE EDGE OF THE PRE-DRILLED HOLES LOCATED AT EACH CORNER OF THE SIDING PANEL. THIS WILL HELP ENSURE THE NAILS WILL BE COVERED WHEN THE FINAL SCREWS ARE INSTALLED.



Fig 9a:

INSTALL BLOCK SIDING PANELS:

>> STEP 4: (OPTIONAL)  
ADDITIONAL BRAD NAILS MAY BE ADDED IN THE MIDDLE OF PANELS LARGER THAN 4'-0" WIDE TO HELP SECURE THE PANEL TO THE WALL.

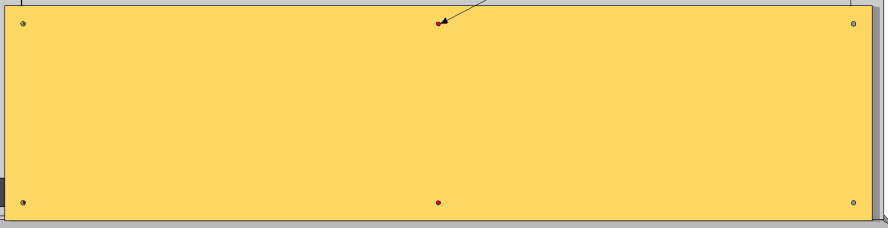

Fig 9b:

INSTALL BLOCK SIDING PANELS:

>> STEP 5:  
CAREFULLY USE A 1/8" Ø DRILL BIT TO DRILL THROUGH ANY METAL TRIM THAT MAY BE PRESENT BEHIND PRE-DRILLED SCREW HOLES (AT PANEL CORNERS).

POSITION HOLE CENTERED WITHIN PRE-DRILLED HOLES.

>> STEP 6:  
USE A PH3 PHILIPS BIT TO INSTALL THE SUPPLIED STAINLESS STEEL SCREWS AND FINISH WASHERS AT EACH PRE-DRILLED HOLE.

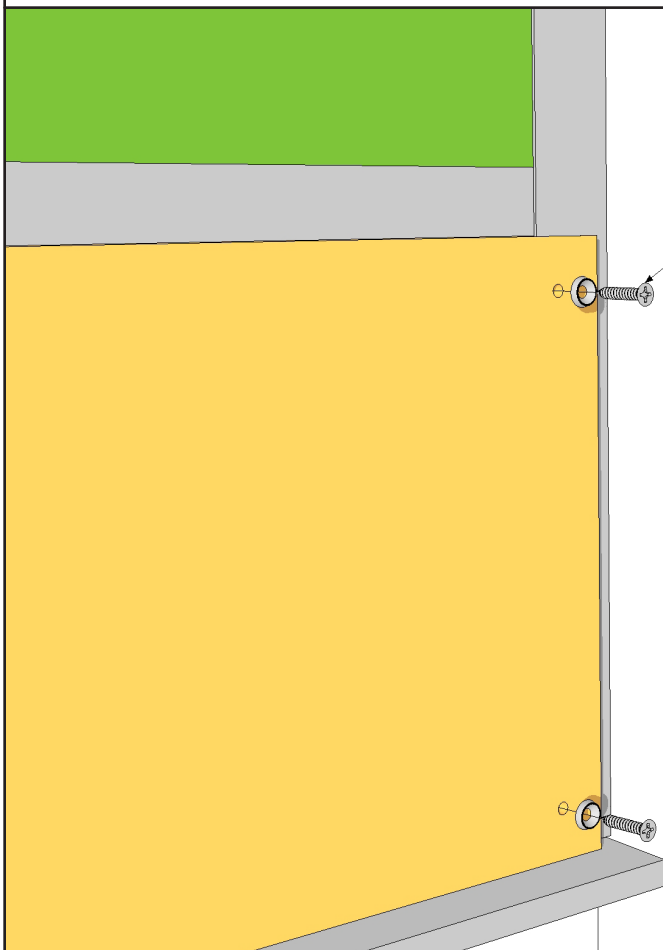
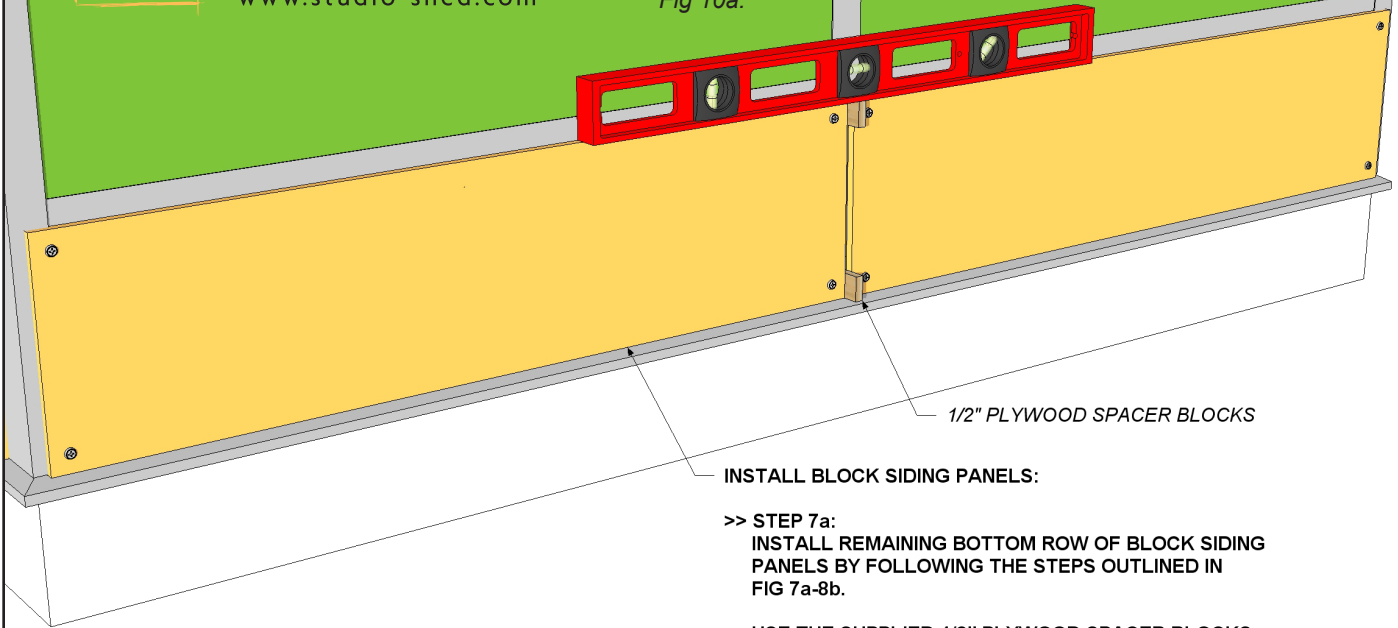

Fig 10a:



1/2" PLYWOOD SPACER BLOCKS

INSTALL BLOCK SIDING PANELS:

>> STEP 7a:  
INSTALL REMAINING BOTTOM ROW OF BLOCK SIDING  
PANELS BY FOLLOWING THE STEPS OUTLINED IN  
FIG 7a-8b.

USE THE SUPPLIED 1/2" PLYWOOD SPACER BLOCKS  
TO ACHIEVE THE 1/2" REVEAL BETWEEN THE PANELS.

Fig 10b:

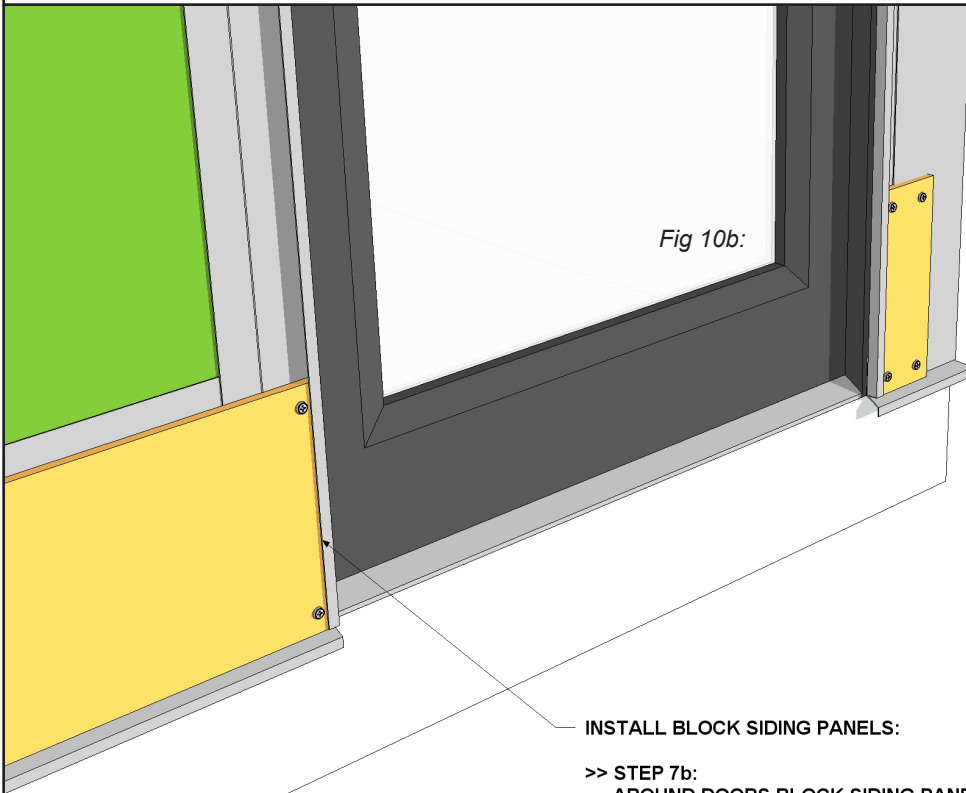

INSTALL BLOCK SIDING PANELS:

>> STEP 7b:  
AROUND DOORS BLOCK SIDING PANELS WILL  
SLIDE INTO DOOR CASING J-CHANNEL (PROFILE O).

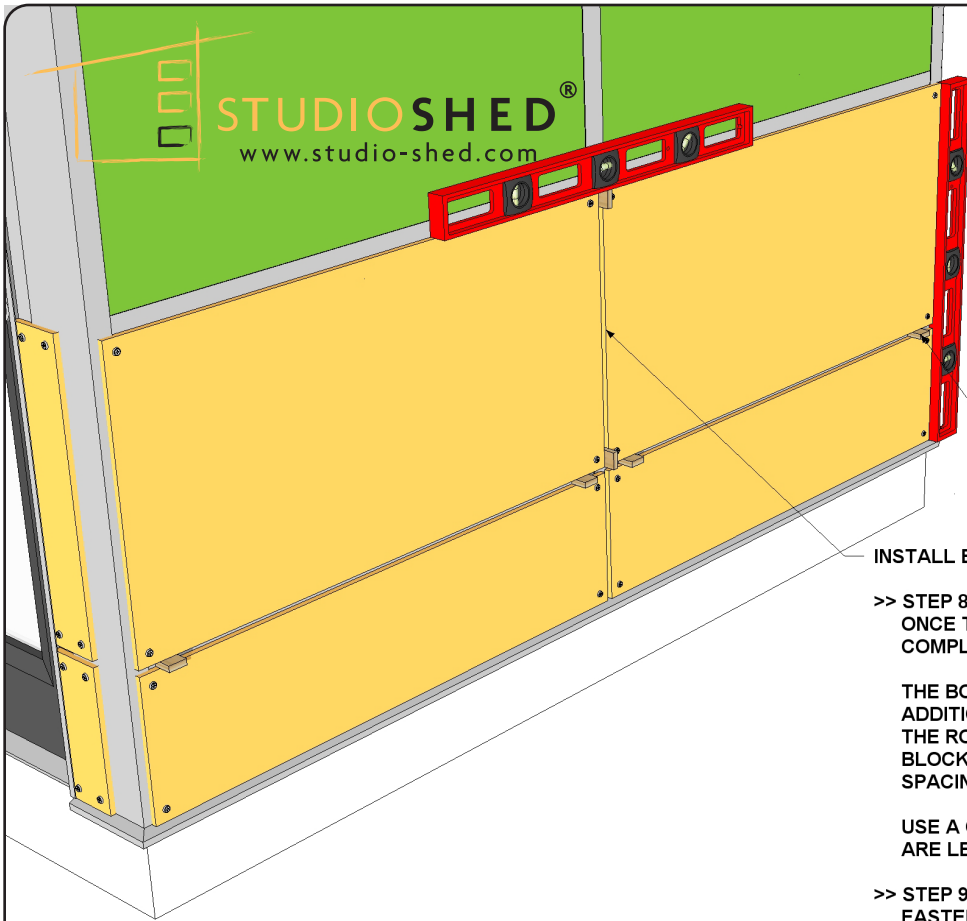

Fig 11a:

1/2" PLYWOOD SPACER BLOCKS

INSTALL BLOCK SIDING PANELS:

>> STEP 8:  
ONCE THE BOTTOM ROW OF SIDING PANELS IS COMPLETE, INSTALL THE NEXT ROW.

THE BOTTOM OF THE NEXT ROW AND ALL ADDITIONAL ROWS WILL BE SPACED 1/2" ABOVE THE ROW BELOW. USE THE SUPPLIED 1/2" SPACER BLOCKS TO ESTABLISH HORIZONTAL AND VERTICAL SPACING.

USE A CARPENTERS LEVEL TO ENSURE PANELS ARE LEVEL PRIOR TO INSTALLING FASTENERS.

>> STEP 9:  
FASTEN SIDING PANELS TO THE SHED BY FOLLOWING THE STEPS OUTLINED IN FIG 7b-8b.

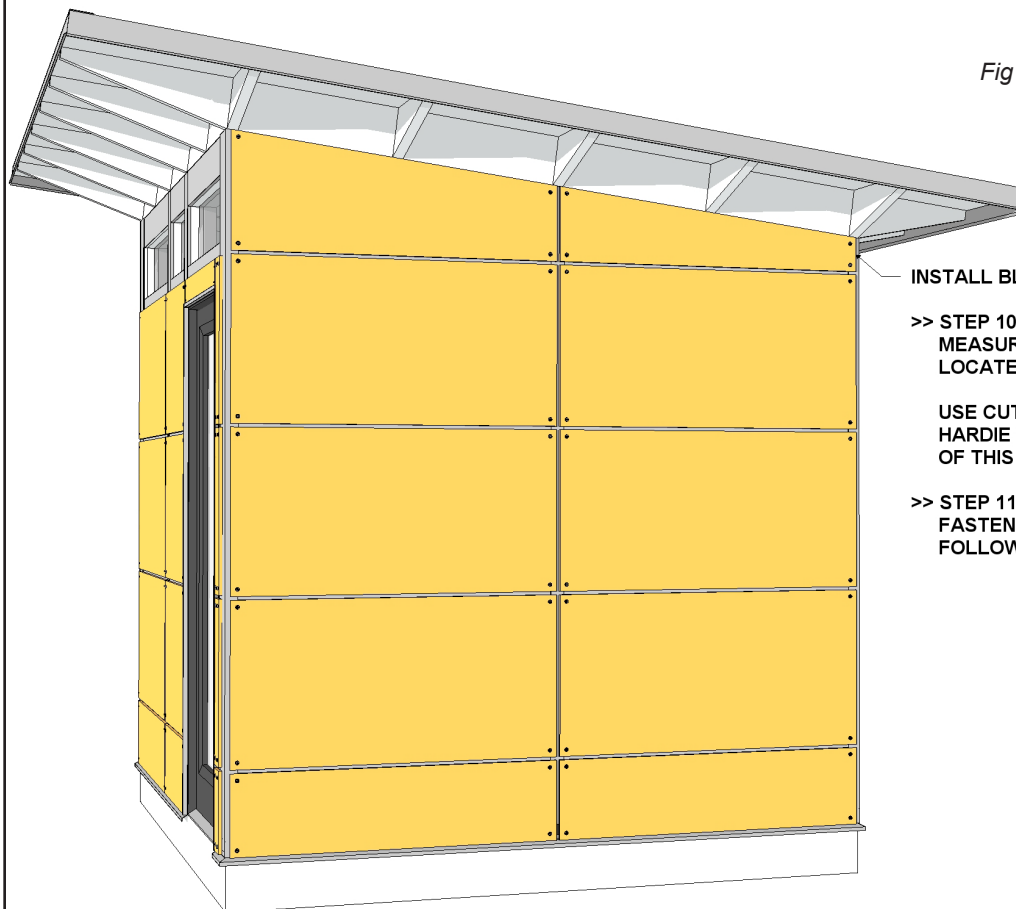

Fig 11b:

INSTALL BLOCK SIDING

>> STEP 10:  
MEASURE AND CUT THE BLOCK SIDING PANELS LOCATED AT THE TOP OF THE SIDE WALLS.

USE CUTTING METHODS DESCRIBED IN THE HARDIE SIDING GUIDE LOCATED AT THE BACK OF THIS INSTALLATION GUIDE.

>> STEP 11:  
FASTEN SIDING PANELS TO THE SHED BY FOLLOWING THE STEPS OUTLINED IN FIG 7b-8b.

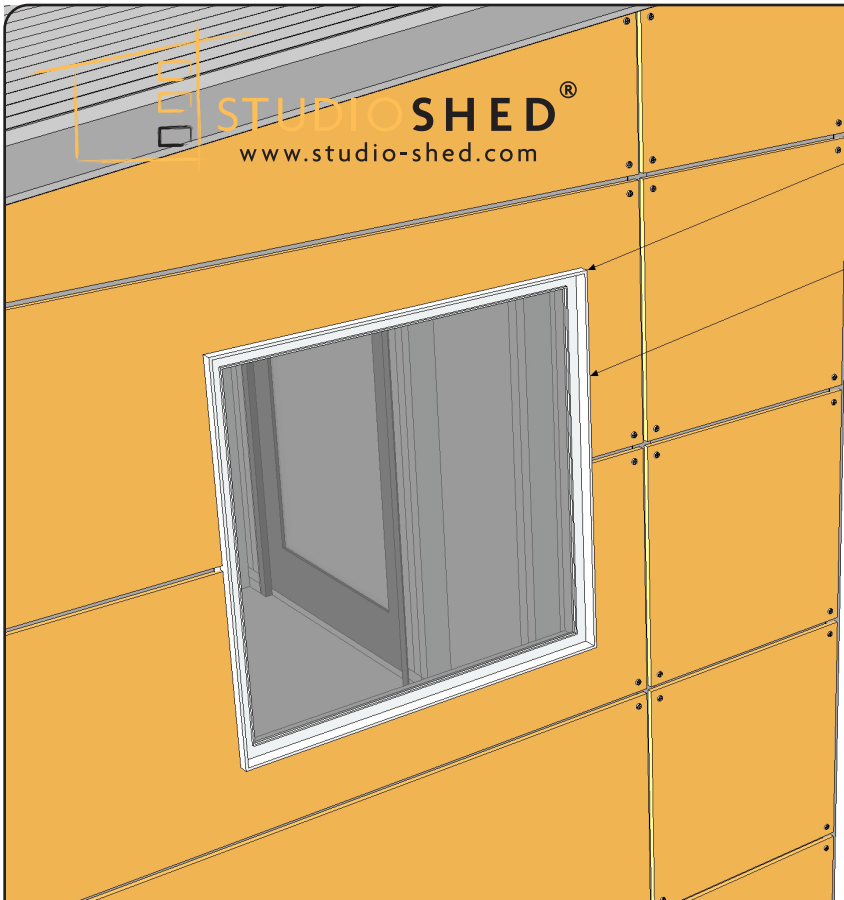

Fig 12a:

WINDOW DRIP EDGE

INSTALL BLOCK SIDING:

- TO ENSURE BEST FIT, SIDING PANELS AROUND OPERABLE WINDOWS ARE SHIPPED UNCUT.

>> STEP 12:

MEASURE AND TRIM TO FIT SIDING PANELS AROUND OPERABLE WINDOWS. THE SIDING SHOULD COVER THE WINDOW NAILING FLANGE AND FIT TIGHT AGAINST THE WINDOW DRIP EDGE.

USE CUTTING METHODS DESCRIBED IN THE HARDIE SIDING GUIDE LOCATED AT THE BACK OF THIS INSTALLATION GUIDE.

>> STEP 13:

FASTEN SIDING PANELS TO THE SHED BY FOLLOWING THE STEPS OUTLINED IN FIG 7b-8b.

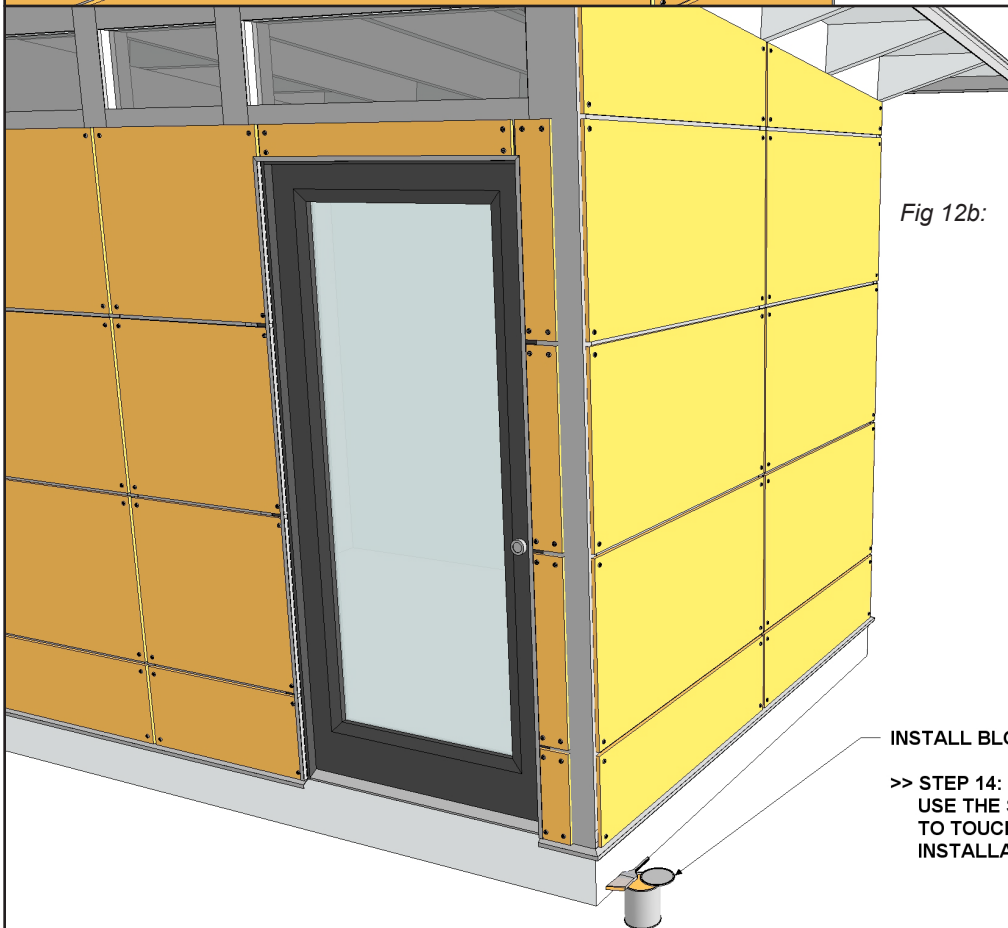

Fig 12b:

INSTALL BLOCK SIDING:

>> STEP 14:

USE THE SUPPLIED COLOR MATCHED PAINT TO TOUCH-UP ANY BLEMISHES CAUSED DURING INSTALLATION.



# **JAMES HARDIE® SIDING PRODUCTS**

## **BEST PRACTICES**

# General Product Information

## JOBSITE STORAGE OF JAMES HARDIE® PRODUCTS

The James Hardie family of siding and trim products, including James Hardie® products with ColorPlus® Technology, should be stored in their original packaging in a garage, shed, or in some other covered area protected from weather whenever possible. These products must be kept covered on a pallet off of the ground; they must never be stored in direct contact with the ground.

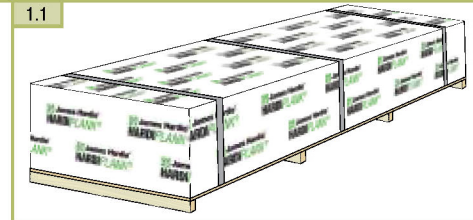

**James Hardie products stored in their original packaging.**

If James Hardie products are stored outside they should be protected with an additional waterproof covering. All scrap siding and trim pieces, cutoffs or material left on scaffolding must be covered and protected from the elements. If James Hardie products become saturated, they must be laid on a flat surface and allowed to dry completely prior to installation.

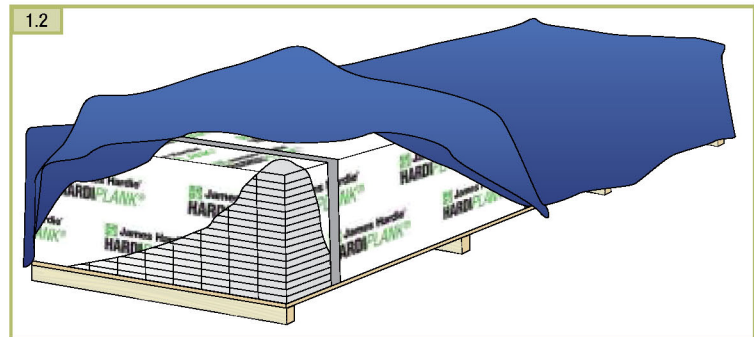

**If stored outside protect with an additional waterproof covering.**



### **WARNING**

James Hardie products should not be rolled-off or dumped-off of the truck during delivery to the jobsite. James Hardie recommends using a fork lift to off load material or unloading by hand.

## IMPORTANCE OF KEEPING JAMES HARDIE PRODUCTS DRY

James Hardie siding and trim products must be kept dry at all times prior to installation. If products become saturated before they are installed, the following problems may occur:

### **OPEN JOINTS DUE TO SHRINKAGE**

If installed wet, joints between planks may open up requiring repair or replacement. Under normal environmental conditions fiber cement has significantly greater dimensional stability than wood or vinyl-based exterior products.

### **DIFFICULTY IN HANDLING**

Saturation increases the weight and flexibility of fiber-cement products, making them difficult to handle.

### **STAINING**

Staining is a deposit of soluble salts, usually white in color, which sometimes appears on the surface of masonry or concrete construction.



### **WARNING**

James Hardie is not responsible for damage due to improper storage and handling of its products.

## PROPER HANDLING OF JAMES HARDIE® PRODUCTS

To help avoid injury and product damage, lap siding, trim and soffit material should always be carried on edge. James Hardie recommends that these products be carried by two people whenever possible with each person positioned near the end of the load. To carry a plank solo, a person should hold it on edge in the middle with arms spread apart for maximum support of the product. Lifting or carrying lap siding or trim flat may break or bend the product.

James Hardie recommends that two people always carry panel products. Workers should hold the panel near each end and on edge. Because of reduced visibility when handling panel products, take extra care to avoid damaging the corners and edges of the panel.

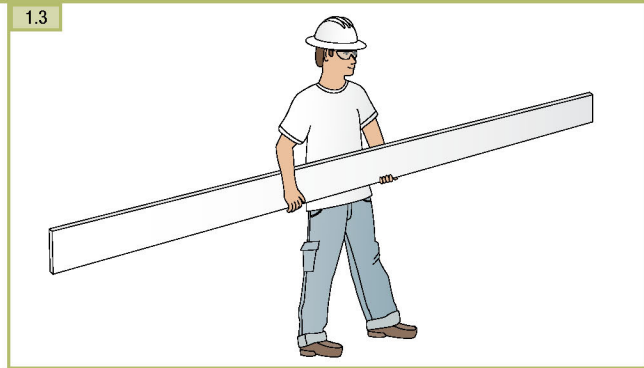

**One person should hold planks on edge in the middle with arms spread apart for maximum support of the product**

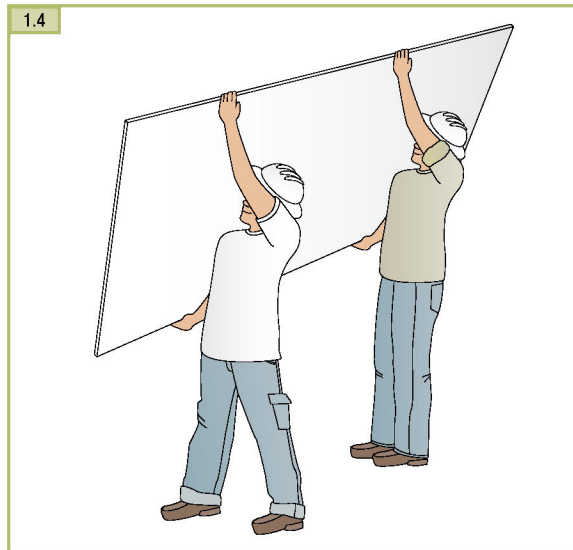

**Two people should always carry panel products.**

**TIP:** When handling panel products, manufactured panel carriers or caddies can give workers better control.



## WARNING

Carrying James Hardie® ColorPlus® siding products flat may cause excessive bending, which can damage the finish.

1.5

WRONG

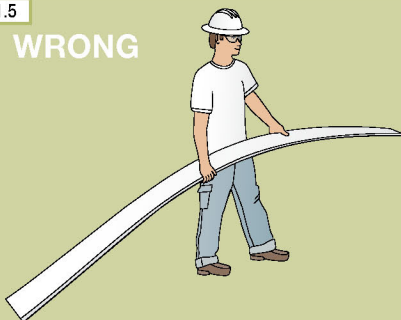

WRONG

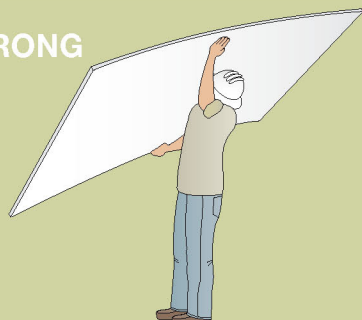

# Working Safely with James Hardie® Products

## MINIMIZE AND MANAGE SILICA DUST

Silica (SiO<sub>2</sub>) is the second most common mineral in the earth's crust, and it's a common ingredient in many building products, including James Hardie® fiber-cement materials. Intact, these products do not pose a silica risk. However, when cut, drilled or abraded during installation, the resulting smaller, silica-containing dust can pose a potential health hazard as inhalation of excessive quantities over an extended period can cause silicosis, lung-cancer or other lung-related diseases, potentially leading to death.



To protect workers from potential health effects, OSHA established and enforces a permissible exposure limit (PEL) for respirable silica set effectively at 0.100 mg/m<sup>3</sup>. This PEL is an 8-hr. time-weighted average and is measured with special industrial hygiene equipment. Any exposure above this level requires that the installer take additional protective measures that might include a documented respirator program and medical monitoring.

James Hardie always encourages installers to take every possible precaution to minimize dust exposure levels. In any situation, properly-fitted NIOSH approved respirators (e.g. N95) can be used in conjunction with the proper tools and cutting methods to further limit silica dust exposures and to provide a safer workplace.

If additional concern regarding dust exposure levels exists, if there is concern about exceeding OSHA's PEL, or if the conditions of your jobsite do not allow you to conform to recommended practices, please contact James Hardie at 1-888-JHARDIE (542-7343), or consult with a qualified industrial hygienist (IH). A directory of independent IH consultants can be found at [www.aiha.org](http://www.aiha.org).

## WORK SAFE: FOLLOW JAMES HARDIE PRODUCT CUTTING INSTRUCTIONS

To create and maintain safer jobsites, James Hardie has developed the following "tiered" system to help select the best tools and methods for any given job. **Note:** For maximum protection (i.e. the lowest respirable dust exposures), James Hardie recommends using "Best" cutting methods and tools whenever possible. Please contact James Hardie or consult with a qualified industrial hygienist if unable to adhere to the recommended cutting instructions.

| Rating | Tools   | Cutting Method   | Cutting Volume  | Ventilation    |
|--------|---|--|-----------------|----------------|
| Best   |  or  | Handheld Shears, Platform Shears, Score and Snap                                   | No Limitations  | Indoor/Outdoor |
| Better |  and | Dust-reducing saws with HardieBlade® saw blade coupled with HEPA vacuum extraction | No Limitations  | Outdoor        |
| Good   |  and | Dust-reducing saws with HardieBlade saw blade                                      | Low to Moderate | Outdoor        |

## CUTTING STATION SET UP

Set up all cutting tables or workstations in well-ventilated outdoor areas so that any generated dust is carried safely away from workers. If an area with adequate ventilation is not available, a NIOSH approved respirator should be used.

### CLEAN UP AND DISPOSAL OF DEBRIS

When cleaning up dust and debris from cutting James Hardie® products, never use a broom or brush if the debris material is dry. Sweeping dry material may send dust particles into the user's

breathing area. Instead, wet down the debris with a fine mist to suppress dust during sweeping or use a HEPA vacuum. Waste pieces of James Hardie siding and trim products can be disposed of in landfills according to local ordinances. No special handling is required.

2.1 Set up cutting station so that the wind carries dust away from the saw operator.

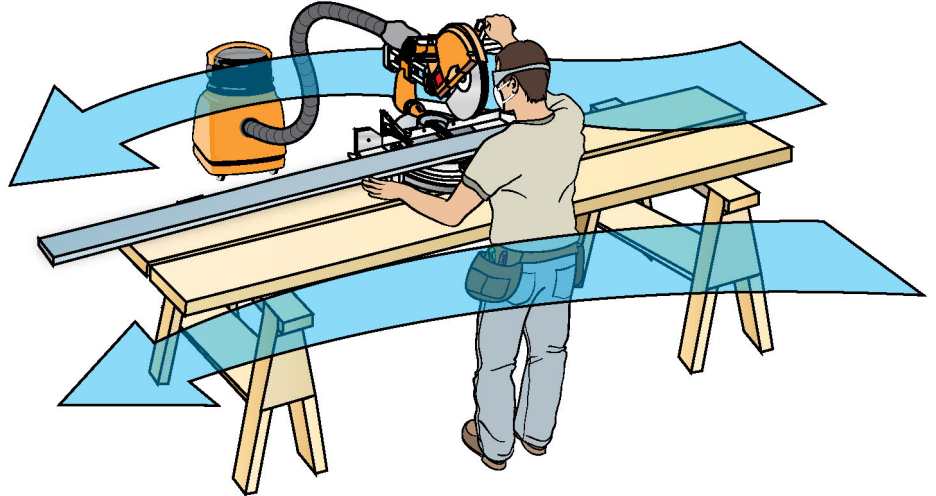

**TIP:** As with any pre-finished building product, care should be taken when handling and cutting James Hardie ColorPlus products. At the job-site use a soft cloth to gently wipe any residue or construction dust left on the product



### WARNING

Never use high-speed power tools when cutting James Hardie® products indoors.



### WARNING

Prior to using any James Hardie® products, all users must read all applicable warnings (including MSDS) and comply with all installation instructions. Failure to do so may result in serious personal injury.

### WARNING: AVOID BREATHING SILICA DUST

James Hardie® products contain respirable crystalline silica, which is known to the State of California to cause cancer and is considered by IARC and NIOSH to be a cause of cancer from some occupational sources. Breathing excessive amounts of respirable silica dust can also cause a disabling and potentially fatal lung disease called silicosis, and has been linked with other diseases. Some studies suggest smoking may increase these risks. During installation or handling: (1) work in outdoor areas with ample ventilation; (2) use fiber cement shears for cutting or, where not feasible, use a HardieBlade® saw blade and dust-reducing circular saw attached to a HEPA vacuum; (3) warn others in the immediate area; (4) wear a properly-fitted, NIOSH-approved dust mask or respirator (e.g. N-95) in accordance with applicable government regulations and manufacturer instructions to further limit respirable silica exposures. During clean-up, use HEPA vacuums or wet cleanup methods-never dry sweep. For further information, refer to our installation instructions and Material Safety Data Sheet available at [www.jameshardie.com](http://www.jameshardie.com) or by calling 1-800-9HARDIE (1-800-942-7343). FAILURE TO ADHERE TO OUR WARNINGS, MSDS, AND INSTALLATION INSTRUCTIONS MAY LEAD TO SERIOUS PERSONAL INJURY OR DEATH.

# Tools for Cutting and Fastening Fiber-Cement Products

James Hardie promotes certain tools and products for the safest and best way to cut their fiber-cement products, consistent with its best practice recommendations (please refer to page 6-7). However, please consult tool manufacturer instructions and guidelines for the safe operation of specific tools. The tools listed here are not made for, or by, James Hardie Building Products, Inc. and James Hardie accepts no liability for their use or misuse.

## SHEARS

Because shears produce less dust than high-speed tools, they are the preferred method of cutting lap and panel siding products. Both electric and pneumatic shears are available, and they may be used for cutting indoors as well as outdoors. Shears are available that can make straight or radius cuts in fiber cement products with relative ease. Shears cannot be used to cut HardieTrim® boards.



**TIP:** For the smoothest cuts, when cutting James Hardie® siding products with a shear or circular saw, cut the board face down. When using a miter saw, cut the board face up. If installing James Hardie siding products with ColorPlus® Technology, leave the protective laminate film in place while cutting.

## CIRCULAR SAWS

When cutting any James Hardie siding, soffit, or trim product with a circular saw, use only tools that are designed specifically for dust reduction. A dust-reducing circular saw has either a deflector to direct any dust away from the user's breathing area or a collection box to capture the dust. James Hardie recommends that a HEPA-equipped vacuum system be used in conjunction with any circular saw. (Circular saws should only be used in outdoor, well-ventilated areas.)



## WARNING

The HardieBlade® saw blade is specifically designed to cut fiber cement products while minimizing the amount of respirable silica dust. Never use continuous-edge diamond blades, abrasive discs, or high tooth count circular saw blades when cutting James Hardie siding products. ONLY blades with the HardieBlade saw blade trademark should be used when cutting.



## WARNING

Always make sure the saw manufacturer's safety equipment is in place and in good working order.

## HEPA VACUUMS

Always use a vacuum equipped with a HEPA filter to help minimize the amount of respirable dust during power saw cutting and clean-up. Many vacuums are designed to connect directly to power tools and run only when the power tool is being operated. In addition to a HEPA filter, using a disposable drywall or collection bag is recommended to extend the life of the HEPA filter and make disposal easier and safer.



## WARNING

**Caution: Tools and blades designed to reduce breathable silica do not always result in safe levels by themselves. Many other factors can influence dust exposure including jobsite ventilation, the amount of material being cut and breathing protection being used. If uncertain about exposure or protection in a specific situation, always consult a qualified industrial hygienist to determine actual exposure levels.**

## POWER MITER SAWS

Like circular saws, a power miter saw should only be operated outdoors in well-ventilated areas. Power miter saws should be equipped with a HardieBlade® saw blade and should be used in conjunction with a vacuum equipped with a HEPA filter for maximum dust protection.

## WARNING

**Never use high-speed power tools when cutting James Hardie® products indoors.**



## SAW BLADES

Traditional blades that are not designed for cutting James Hardie products may generate excessive dust, cut slowly, or exhibit premature wear. The HardieBlade® saw blade is a unique circular saw blade designed to generate less respirable dust than a traditional saw blade or continuous rim diamond blade. The HardieBlade can also be used to cut the full line of James Hardie products and are available in 7 1/4-in., 10-in., and 12-in diameters. To extend the life of a HardieBlade saw blade, do not use it to cut any materials other than fiber cement.



# Tools for Cutting and Fastening Fiber-Cement Products (continued)

## JIG SAWS

Jig saws equipped with a fiber-cement cutting blade may be used to cut service openings, curves, radii, scrollwork, and other irregular shapes in James Hardie® products. Because most jig saws are not equipped with dust collection capabilities, these tools also should only be used outdoors in well-ventilated areas and for limited amounts of cutting.



## DRILLING FIBER CEMENT

When required to drill a hole in fiber cement products, a masonry bit should be used. For larger holes, a carbide tipped hole saw can be used. Due to the lack of dust collection, drills and hole saws should only be used outdoors in well-ventilated areas and for limited amounts of cutting. For best results, use a hole saw specifically designed for fiber cement.



[www.malcoproducts.com](http://www.malcoproducts.com)

## LAP GAUGES

Several different methods exist to ensure proper spacing and overlap of fiber cement products. The slowest method is to snap a chalk line with the proper spacing above each row of fiber cement as it is being installed. Break-away clips can be used, but they add extra cost to the installation of the product. Standard lap gauges can be used if two or more people are installing the product. Overlap and siding gauges allow one person to install siding by themselves. The Siding Gauge leads all other alignment devices in ease of use, speed, and effectiveness. James Hardie recommends the use of Siding Gauge when installing lap siding.

